

RICO

Thermal Imaging Riflescope

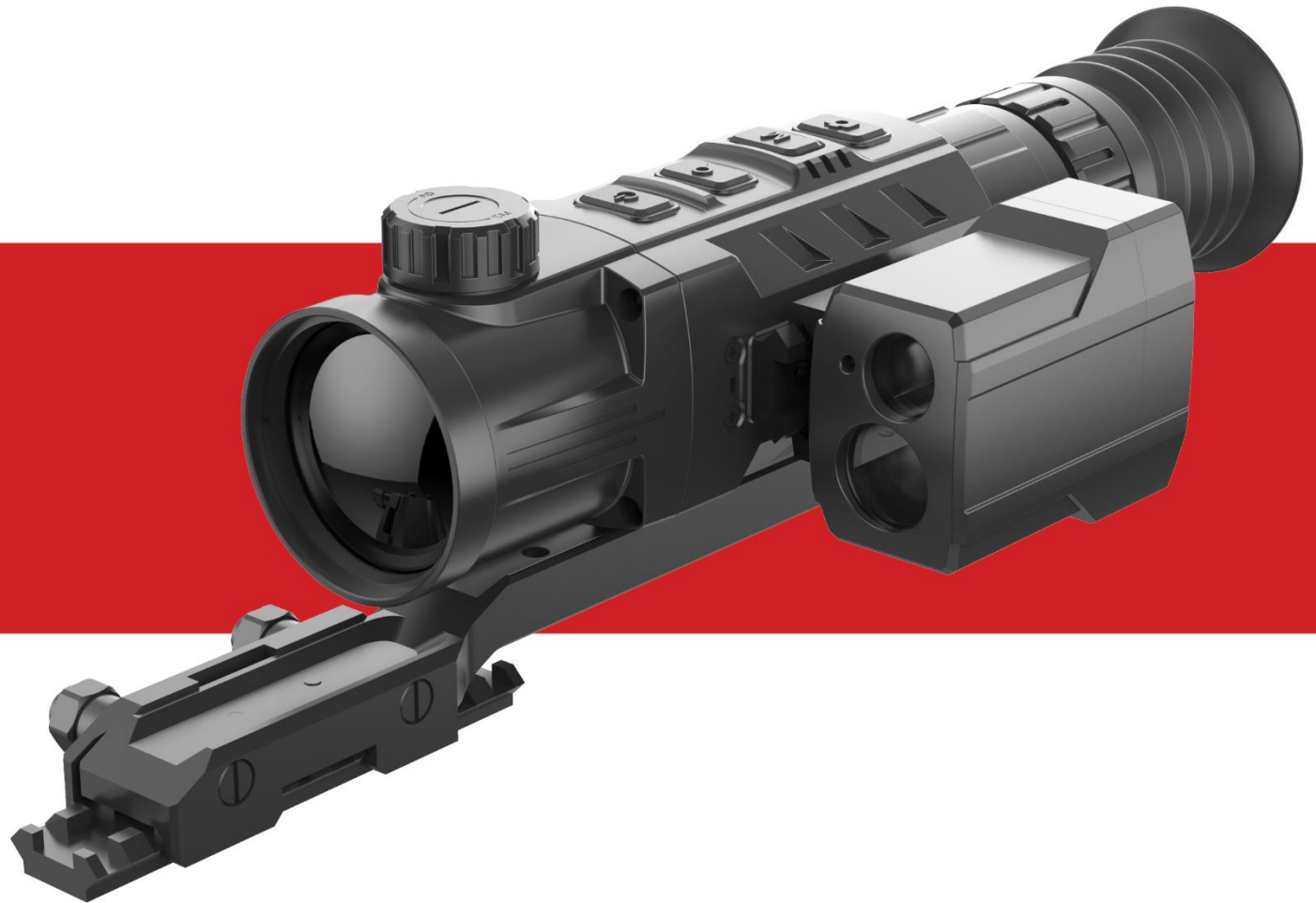

User Manual

RL42 / RH50

V1.4

Important Safety Information

Environmental influences

- Never point the lens of the device directly at intense heat sources such as the sun or laser equipment. The objective lens and eyepiece can function as a burning glass and damage the interior components.
- Avoid touching the metal surface (cooling fins) after exposure to sunlight or cold.

Risk of swallowing

Caution: Do not place this device in the hands of small children. Incorrect handling can cause small parts to come loose which may be swallowed.

Safety instructions for use

- Handle the device with care: rough handling can damage the internal battery.
- Do not expose the device to fire or high temperatures.
- Always store the device in its carrying bag in a dry, well-ventilated space.
- The recommended temperature for using this product is -20° to +50°. Temperature exceeding this range will affect the service life of the

product.

- Do not store the device for long periods at temperatures below 20°C or above 50°C. This permanently reduces the capacity of the battery.
- If the device has been damaged, send the device to our after-sales service for repair.

Safety instructions for the power supply unit

- Check the battery pack, cable and adapter for visible damage before use.
- Install the battery pack correctly according to the instruction on the device. Reverse connection is prohibited.
- Only use the battery charger to charge the battery pack supported in the package.
- Only charge the device at temperatures ranging between 0°C and 40°C.
- The battery capacity decreases when operated in a cold ambient temperature. This is not a fault and occurs for technical reasons.
- Do not use any defective parts. Defective components must be replaced.
- Do not use the power supply unit in wet or humid environments.
- Only use the original cable provided with the battery charger.
- Do not make any technical modifications.

Disposal of batteries



Directive 2006/66/EC (battery directive): This product contains a battery that cannot be disposed of as unsorted municipal waste in the European Union. For battery details, refer to the documentation of the specific product. The battery is marked with this symbol, which may include Cd (indicating cadmium), Pb (indicating lead), or Hg (indicating mercury). For proper recycling, please return the battery to your supplier or send it to a designated collection point. For more information, visit www.recyclethis.info.

User information on the disposal of electrical and electronic devices (private households)



2012/19/EU (WEEE directive): Products marked with this symbol cannot be disposed of as unsorted municipal waste in the European Union. For proper recycling, return this product to your local supplier upon the purchase of equivalent new equipment, or dispose of it at designated collection points. For more information see: www.recyclethis.info.

For business customers within the European Union

Please contact your dealer or supplier regarding the disposal of electrical and electronic devices. He will provide you with further information.

Information on disposal in other countries outside of the European Union

This symbol is only applicable in the European Union. Please contact your local authority or dealer if you wish to dispose of this product and ask for a disposal option.

Intended use

The device is intended for displaying heat signatures during nature observation, remote hunting observations and for civil use. This device is not a toy for children.

Use the device only as described in this operating manual. The manufacturer and the dealer accept no liability for damages which arise due to non-intended or incorrect use.

Function test

- Before use, please ensure that your device has no visible damage.
- Test to see if the device displays a clear, undisturbed image.

- Check that the settings for the thermal imaging monocular are correct.

See the notes in the section **Operation - Power On and Image Settings**.

Installing / Removing the battery

The Rico series thermal imaging riflescope is equipped with a battery pack.

The battery pack can be moved and charged, referring to the section

Battery Charging for details.

1 Technical Specifications

Model	RL42	RH50
Microbolometer		
Type	Uncooled	
Resolution, pixels	384×288	640×512
Pixel Size, um	12	
NETD, mk	≤40	
Frame Rate, Hz	50	
Optical Characteristics		
Objective Lens	F42mm /1.1	F50mm /1.1
Field of View, degrees	6.3 × 4.7	8.8 × 6.6
Magnification, ×	4~16	3~12
E-zoom, ×	1 / 2 / 3 / 4	
Eye relief, mm	55	
Exit pupil diameter, mm	6	
Diopter Adjustment, D	-4~+4	
Detection Range, m (Target size: 1.7m×0.5m, P(n)=99%)	2179	2594
Display		
Type	AMOLED	
Resolution, pixels	1024×768	

Size, inch	0.39	
Power Supply		
Battery Type / Capacity / Output Voltage	Li-Ion Battery Pack IBP-1 / 4400mAh / DC3.7V	
Power Supply	3V~4.2V	
External Power Supply	5V (Type C USB)	
Operational Characteristics		
Max. Operating Time (at t=22°C), h*	6	
Max. Recoil Power on Rifled Weapon, g/s ²	1000	
Degree of protection, IP code	IP67	
Amount of built-in memory, Gb	32	
Operating Temperature Range, °C	-20~+50	
Laser Rangefinder	Optional	
Weight, g	820	830
Dimension, mm	250×65×58	250×61×58
Characteristics of Rangefinder		
Wavelength, nm	905	
Max. Measuring Range, m/y**	1000/1094	
Measurement Accuracy, m	±1	

* The actual operating time depends on the intensity of using Wi-Fi, video recorder, laser rangefinder.

★★ The measuring range depends on the characteristics of the object under observation and environmental conditions.

- Improvements may be made to the design and software of this product to enhance its useful features without prior notice of the customer.
- The newest user manual can be downloaded at our official website: www.infirayoutdoor.com.

2 Package Contents

- Rico Series Thermal Imaging Riflescopes
- IRM-030-205-Q1 picatinny mount
- IBP-1 battery pack
- IBC-1 battery charger for battery pack
- Power adapter
- Data cable
- IPB-3 portable bag
- Lens cloth
- A L-shaped wrench

3 Description

The thermal imaging riflescope Rico series are designed for the use on hunting rifles both in the nighttime and in the daylight in inclement weather conditions (rain, snow, fog or smog) to see through obstacles hindering detection of targets (tree branches, tallgrass and shrub etc.). Unlike the night vision devices, the Rico series do not require an external source of light and are not affected by strong lights. A high precision laser rangefinder is optional with Rico series which allows distance measurement up to 1000 meters.

Rico series can be widely used in the night hunting, observation and terrain navigation, search and rescue operations etc.

4 Features

- 12μm high resolution thermal detector
- High image quality
- Aluminum alloy housing
- Maximum detection range 2600m
- Optional laser rangefinder

- Quick replacing recharging battery pack
- HD AMOLED display:1024*768
- High frame frequency: 50Hz
- Three save sort for rifle types
- Digital Zoom: ×1/×2/×3/×4
- Build-in 32GB storage, supports photographing and video recording
- Build-in Wi-Fi module
- InfiRay Outdoor App support
- Build-in digital compass and motion sensor
- Variable reticle types and color
- Ultraclear mode
- Support PIP and pixel calibration functions
- User friendly interface



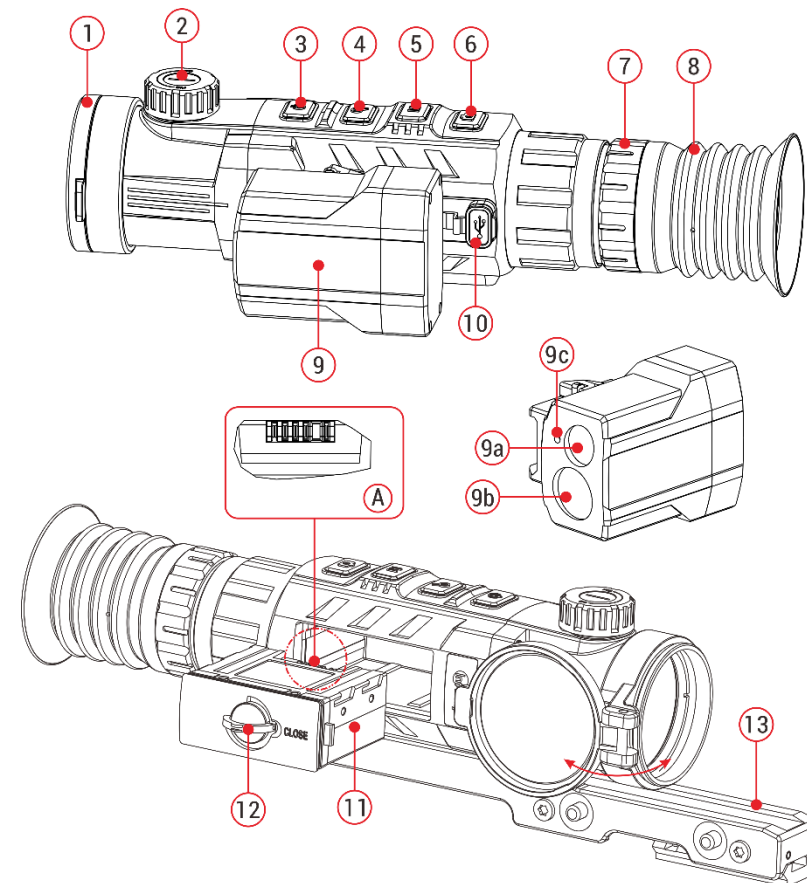

- 4. Up button / Zoom button
- 5. Menu button / M button
- 6. Down button / Camera button
- 7. Eyepiece adjustment ring
- 8. Eyeshade
- 9c. Laser indicator
- 10. Type C port
- 11. Battery pack
- 12. Battery pack ring
- 13. IRM-030-205-Q1 rifle mount

5 Components and Controls

- 1. Lens cover
- 2. Lens focus knob
- 3. Power button
- 9. Laser Rangefinder (Optional)
- 9a. Laser launch port
- 9b. Laser receive port



6 Description of Controls

Button	Status / Current Operation Mode	Short Press	Long Press
Power Button 	Device is off	—	Power on the device
	Device is on	Calibrate the detector	Power off / Standby the device
	Standby mode	Wake up the device	—
	Single rangefinder Mode	Distance measurement	—
	Main menu	Exit menu without saving	—
	Defective pixel calibration	Add/Delete defective pixel	—
Up / E-zoom Button 	Home screen	Digital Zoom	PIP on/off
	Main menu / Quick menu	Navigation upwards	—
Menu Button 	Home screen	Enter quick menu	Enter main menu
	Quick menu	Switch and confirm parameters	Save and exit to home screen
	Main menu	Enter the submenu / Confirm selection	
	Defective pixel calibration	Confirm selection / Save position	
Down/Photography Button 	Home screen	Take a Photograph	Start video recording
	Main menu / Quick menu	Navigation downwards	—
	Video recording	Take a Photograph	Stop and save video
Up + Down Button	Main menu	—	Active the rangefinder mode
	Rangefinder mode	Switch between single and continuous mode	Turn rangefinder mode off
Menu + Down Button	Rangefinder mode	—	Turn laser indicating on/off
Up + Menu + Down Button	Home screen	—	Turn reticle function on/off

7 Battery Pack

Rico series are supplied with a rechargeable Li-ion Battery Pack IBP-1 which allows operation for up to 6 hours. Please Remember to charge the Battery Pack before first use.

Battery Pack Charging

- Install the Battery Pack into the battery pack charger (14) by inserting the pins (A) of Battery Pack with the groove (B) of battery pack charger (14).
- Connect the Type C plug of the data cable to the port (C) of battery pack charger (14).
- Connect another port of the data cable to the power adapter.
- Insert the plug of the adapter to the 240V socket;
- Upon installation, the LED indicator (D) on the battery pack

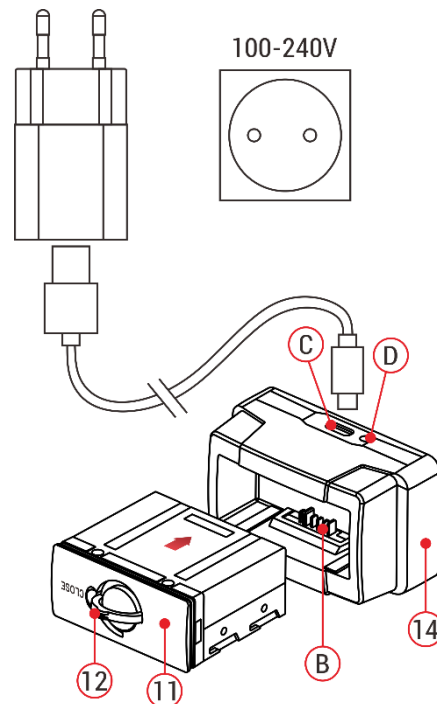

charger (14) will start to glow or blink:

- When charging is progressing, the LED indicator is glowing continuously red;
- When LED indicator lights green continuously, the battery is fully charged;
- If the battery pack charger is connected to power supply but no battery pack installed, LED indicator is blinking with red color.

- When fully charged, plug out and take battery pack from the charger.

Battery Pack Installation

- Pull out and rotate the Battery Pack Ring (12) 90 degrees clockwise.
- Install the Battery Pack by inserting the pins of Battery Pack with the groove on the Rico housing.
- When the battery pack is fully inserted into the Rico housing, rotate the Battery Pack ring (12) 90 degrees anticlockwise to lock the Battery Pack (11).
- Upon installation, flip down the ring (12), and the raised part of the ring (12) is pointing to the sign "CLOSE" on Battery Pack (11).



Safety Precautions

- Only use the charger **(14)** supplied with the Battery Pack. The use of any other charger may irreparably damage the Battery Pack or the charger and may cause fire.
- Partial charging the battery is necessary if the battery is planned to be idled for long time. Avoid fully charged or discharged.
- Don't charge the battery instantly while bring the battery from cold environment to warm environment. Leave 30-40 mins before charging;
- Don't leave battery unattended when charging;
- Never use a damaged or modified charger;
- Charge the Battery Pack at a temperature from 0°C to +45°C, otherwise the battery life will be reduced significantly.
- Don't leave the Battery Pack with a charger connected to the mains longer than over 24 hours after full charge.
- Do not expose the battery pack to high temperature or to a naked flame.
- Do not submerge the battery pack in water.
- Don't connect external device with a current consumption that exceed permitted levels.
- The Battery Pack is short circuit protected. However, any situation that may cause short-circuiting should be avoided;

- Don't dismantle or deform the Battery Pack.
- Don't hit or drop the battery
- The battery capacity may decrease when using the battery in negative temperature, that is normal, not a defect.
- Avoid using the battery at the temperature above the temperature shown in the table, this may decrease the battery's life.
- Keep the battery out of the reach of children.

8 External Power Supply

Rico series support external power supply, such as the mobile power bank (5V).

- Connect the external power supply to the USB port **(10)** on Rico.
- The riflescope will switch to operation from external power supply, and the IBP-1 Battery Pack will begin slowly charging.
- The display will show the battery icon  with charge level as a percentage.
- If the device is connected with external power supply but without the Battery Pack, the battery icon turns into USB icon .

- While external power supply is disconnected, the riflescope will switch to the Battery Pack without powering off.

9 Operation

Installation of Rifle Mount

- Before using the Rico series, you need to install the Rifle Mount **(13)** on the bottom of your riflescope.
- The mounting holes **(15)** in the base of the riflescope enable the Mount **(13)** to be installed in one of the multiple positions.
- The choice of the mounting position helps the user to ensure the correct eye relief distance depend on the rifle type.
- Fix the Rifle Mount **(13)** to the base of the riflescope with a L-shaped wrench and M5 screws **(16)** supplied in the package.
- Install the riflescope on your hunting weapon and make sure that the chosen position is suitable for you.
- Remove the riflescope from your weapon.
- Unscrew the screws one by one, apply some thread sealant onto the thread of screws and tighten them fully (do not overtighten). Let the

sealant dry for a while.

- While the sealant is dry, the riflescope is ready to be installed on your weapon and to be zeroed.
- After first installation of the riflescope on your weapon. Please follow instructions in the section 9 **“Zeroing”**.

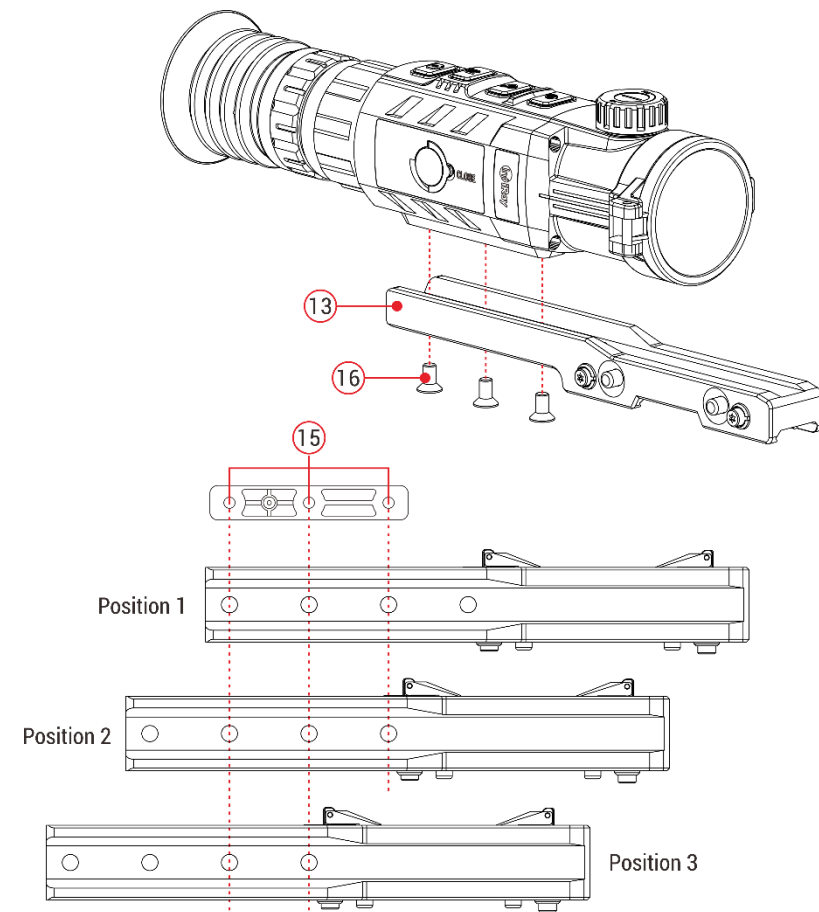

Power On and Image Settings

- Open the lens cover (1).
- Press and hold down the **Power (3)** button to turn on the scope.
- Rotate eyepiece diopter adjustment ring (7) until images in eyepiece are clear. After this, there is no need to rotate the eyepiece adjustment ring (7) for distance or any other conditions.
- Rotate the lens focus knob (2) to focus on the object being observed.
- To set up display brightness, image contrast, image modes and digital zoom, please refer to the **Quick Menu Function** section.

- After use, hold down the **Power (3)** button for about 3 seconds, there will be prompts of standby and count down of switch off.

Release the button until a prompt of saving data appears on the screen after counting down from 3 to 0, and the device will switch off after saving data.

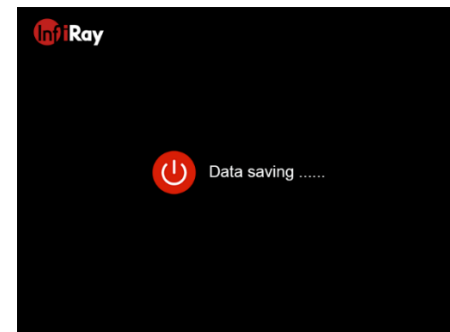
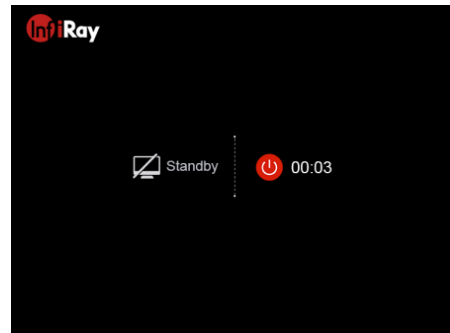



Please don't cut off power supply when saving data, otherwise the data may not be saved.

- Release button before the countdown finish, then device will enter the standby mode. Short press the **Power (3)** button again to wake it up.

10 Zeroing

Rico series feature to use the “Freeze” zeroing method. Zeroing should be done at the operation temperatures by following the order of these steps:

- Mount Rico on your weapon according to the instructions of section 8 **Installation of Rifle Mount.**
- When using Rico for the first time, press the **Up (4) + M (5) + Down (6)** three buttons at the same time for more than 10 seconds to active the hidden functions about reticle and zeroing functions.
- Set a target at a certain distance.
- Adjust the riflescope according to the instructions of section 8 **Power on and image settings.**
- Select the zeroing profile (refer to “Reticle - Zeroing Profile” in Main Menu).

- Press and hold down the **M (5)** button to enter the Main Menu.
- Briefly press the **Up (4)** or **Down (6)** button to select the **Zeroing** item. Then press **M (5)** button to enter the submenu.
- Base on the preset target distance to select zeroing distance in the zeroing submenu or add a new distance (refer to Main Menu option **Zeroing** - submenu **Zeroing Distance** - **Reset Zeroing Distance**).
- After setting the zeroing distance, select the Zeroing option  and briefly press the **M (5)** button to enter Zeroing interface (see the Main Menu option **Zeroing** - submenu **Zeroing Distance** - submenu **Zeroing**). The X and Y coordinates of the reticle are displayed in the upper left corner of the screen.
- Aim and shoot the target.
- Observe the location of impact. Suppose that the red cross hairs in the right picture represents the impact point, but the cross is only as a sign and does not appear on the actual interface.
- If the impact point does not match the aiming point (the center of the reticle), keep the reticle center the aiming point, then press and hold down the **UP (4)** and **Down (6)** button at the same time until a symbol of freeze  appears on the left of the screen, and the image is frozen.



- Select the movement direction between X (the default direction) and Y with the **Up (4) / Down (6)** button, and confirm your selection with a short press of the **M (5)** button, meanwhile the icon turns into blue and continuously flashing.
- Then, move the reticle with a short or long press the **Up (4) / Down (6)** button until the reticle matches the point of impact.
- Press the **Up (4)** button to move the reticle right or up and the **Down (6)** button to move the reticle left or down. Short press to move one pixel (1.07cm) every time and long press to move ten pixels (10.7cm) once.
- When moving the reticle, a white dot appears on the screen, representing the original position of the reticle.
- When the reticle moves to the impact point, press and hold the **M (5)** button to save the new position of the reticle and exit to the home screen.
- Take another shot – the point of impact should now match the aiming

point.

11 Calibration

Calibration enables to equalize the detector temperature and eliminate the image defects (such as vertical bars, phantom images, etc.).

There are three calibration modes: Automatic (**A**), Manual (**M**) and Background (**B**).

Select the required calibration mode in the Main Menu.

- **A mode (Automatic)**. Device will calibrate automatically according to the software algorithm. There is no need to close the lens cover (the internal shutter covers the sensor). Before automatic calibration, there will be a 5 second countdown prompt behind the shutter icon on the status bar, that can be cancelled this calibration during countdown with a short press of the **Power (3)** button. In this mode, the riflescope may be calibrated by user with the **Power (3)** button.
- **M mode (Manual)**. Press the **Power (3)** button briefly to activate the shutter calibration without closing the lens cover (the internal shutter covers the sensor).

- **B mode (Background)**. Close the lens cover and press **Power (3)** button briefly. A prompt appears on home screen as “cover lens during calibration”, background calibration starts after 2s.

12 Digital Zoom

Rico series support to quickly increase the basic magnification by 2 times, 3 times or 4 times, as well as to return to the basic magnification.

- In the home screen, briefly press the **Up (4)** button to operate the incremental digital zoom. in loop to switch magnification times and the status reveal on the top status bar.
- For Rico RL42, the apparent magnification of ×1 to ×4 digital zoom is 4×, 8×, 12×,16×; and for RH50 is 3×, 6×, 9×, 12×.

13 Photography and Video Recording

Rico series is equipped with a function for video recording and photography of the observed image which is saved on the built-in 32GB memory storage. The photo and video files are named with time, so it is suggested to reset

the date and time in the Main Menu before using the photo and video functions (refers to **Main Menu - Settings - Date/Time Setting** in this manual) or to synchronize date and time in the InfiRay Outdoor application.

Photography

- Press the **Camera (6)** button in the home screen to take a photo. The image freezes for 0.5 sec with a camera icon  appears on the upper left corner of screen.
- Photos are stored in the built-in storage.

Video Recording

- In the home screen, press and hold down the **Camera (6)** button to start video recording.
- When the video recording starts, the icon  and the video recording timer displayed in the HH:MM:SS (hour: minute: second) format will appear on the upper right of the screen.
- When recording, short press the



Camera (6) button to take a photo.

- Press and hold down **Camera (6)** button to stop and save the video recording.
- All videos and photos will be saved in the built-in storage.

Note:

- You can enter and navigate the menu during video recording.
- Recorded photos and videos are saved in built-in memory card of the device in the format IMG_HHMMSS.jpg (for photos) and VID_HHMMSS.mp4 (for videos). HHMMSS - Hour/Minute/Second.
- The maximum duration of a recorded video file is 5 minutes. After this time expires, the video is recorded to a new file automatically.
- The number of the recorded files is limited by the capacity of the internal memory.
- Check the available space of the built-in storage card regularly and move the footage to other storage media to free up the memory card space.
- Graphic data (status bar, icons and menu) in the recorded video and photo files are not displayed.

Memory Access

When the device is turned on and connected to a computer, it is recognized by the computer as a flash memory card, which is used to access the device's memory and make copies of pictures and videos.

- Turn on the riflescope and connect it with the computer via Type-C cable.
- Double click “my computer” on the desktop - double click to open the

device named “InfiRay”  - double click and open the device

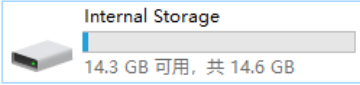
named ‘Internal Storage’  to access built-in memory.

- There are different folders named by time in the storage  20191218

- Recorded photos and videos in that day are saved in the folders
- Select desired files or folders to copy or delete.

14 Status Bar



The status bar is at the top of the screen and shows information on the actual operating status of the riflescope, from left to right are:





1. Current image mode (: White Hot; : Black Hot; : Red Hot; : Target Highlight; : Pseudo color)
2. Actual zeroing type and distance (such as A100m)
3. Ultraclear mode (: Ultraclear off; : Ultraclear on)
4. Current magnification (such as 3.0x)
5. Calibration Mode (a countdown timer 00:05 will appear instead of the calibration mode with 5 seconds remaining until automatic calibration). The timer will appear only after the microbolometer temperature has stabilized (after 10 minutes of continuous operation of the riflescope). Immediately after turning on the riflescope the shutter calibration activates automatically without displaying the timer.
6. Compass (when it is on)
7. Standby status and time
8. Video output status (when it is on)

9. Microphone Status (🔇: microphone off; 🎤: microphone on)

10. Wi-Fi Status (📶: Wi-Fi off; 📶: Wi-Fi on)

11. Clock (set clock in the App “InfiRay Outdoor” or the Main Menu)

12. Battery status

Icon	Color/Status	Battery Status
	Green	more than 40%
	Yellow	20% - 40%
	Red	Less than 20%, need to charge instantly
	Lightning icon inside	External power supply meanwhile charging the Battery Pack
	USB icon	External power supply without Battery Pack in the riflescope

15 Quick Menu Function

The basic settings (including image mode, display brightness, image sharpness and zeroing distance) can be changed in the Quick Menu.

- In the home screen, short press the **M (5)** button to enter the Quick Menu.

- Switch the function items as described below with a short press of **Up (4)** button **or Down (6)** button. The selected items will be highlighted in background:

- **Image Mode:** short press the **M (5)** button to switch image modes among White Hot, Black Hot, Red Hot, Pseudo Color and Target Highlighting mode.



- **Display Brightness:** short press the **M (5)** button to change brightness level from 1 to 5.
- **Image Sharpness:** short press the **M (5)** button to switch the image sharpness from 1 to 5.
- **Zeroing Distance:** short press the **M (5)** button to change default zeroing distance under the current zeroing profile (if you select the profile A, you can only switch the distance saved in the profile A).
- Press and hold down the **M (5)** button to save modifications and exit the menu or wait 5 seconds to exit automatically.

16 Main Menu

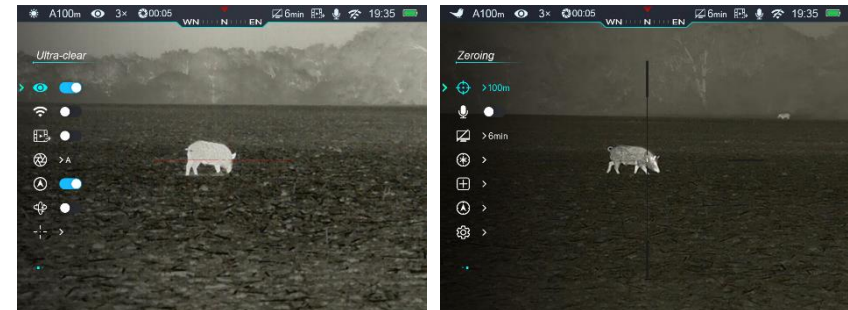

- Enter the main menu with a long press of the **M (5)** button in home screen.
- Briefly press the **Up (4)** button or **Down (6)** button to toggle between the main menu options.
- Main menu navigation is cyclical: as soon as the last menu option of the first tab is reached, the first menu option of the second tab starts.
- Adjust the current parameters or enter the submenus with a short press of the **M (5)** button.
- In all menu interfaces, long press the **M (5)** button to save the modification and exit to the home screen. And short press the **Power (3)** button to return to the previous menu without saving.

- Automatic exiting from the main menu to the home screen will occur after 15 seconds of inactivity.
- Upon exit from the main menu the cursor location is stored only for a single working session (i.e. until the riflescope is turned off). Upon restarting the riflescope and entering the menu the cursor will be on the first menu item.











Main Menu Options and Descriptions





<p>Ultraclear</p> 	<p>Turn Ultraclear mode on/off</p> <ul style="list-style-type: none"> ● Press and hold down the M (5) button to enter the Main Menu. ● Select the Ultraclear menu option with the Up (4)/Down (6) button. ● Turn Ultraclear mode on /off with a short press of M (5) button, along with the sound of shutter calibration.
<p>Wi-Fi</p>	<p>Turn Wi-Fi on/off</p>

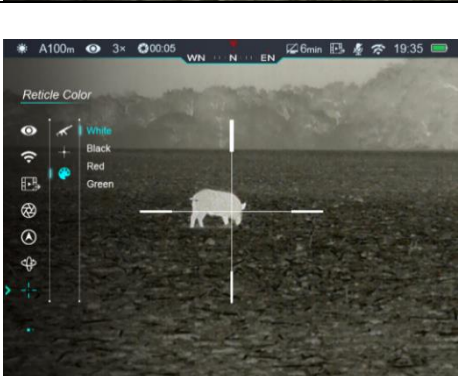

	<ul style="list-style-type: none"> ● Press and hold down the M (5) button to enter the Main Menu. ● Select the Wi-Fi menu option with the Up (4)/Down (6) button. ● Briefly press of the M (5) button to turn Wi-Fi on /off
<p>Video Output</p> 	<p>Turn video output on/off</p> <ul style="list-style-type: none"> ● Press and hold down the M (5) button to enter the Main Menu. ● Select the Video Output menu option with the Up (4)/Down (6) button. ● Briefly press of the M (5) button to turn video out on/off. ● Video out function enable connectivity with an eternal display or recording device.
<p>Calibration</p> 	<p>Select calibration mode</p> <p>There are three calibration modes: Automatic(A), Manual (M) and Background (B). The selected calibration mode is displayed in the status bar (see Status Bar section).</p> <ul style="list-style-type: none"> ● Press and hold down the M (5) button to enter the Main Menu. ● Select the Calibration menu option with the Up (4)/Down (6) button. ● Briefly press of the M (5) button to enter the submenu. ● Press Up (4)/Down (6) button to select one mode from the following modes: <ul style="list-style-type: none"> - Automatic. The software determines the need for calibration in automatic mode. The calibration process starts automatically. - Manual. The user independently determines the need for calibration based on the quality of the observed image. - Background. Close the lens cover before starting the calibration. ● Briefly press M button to confirm your selection.





<p>Compass</p> 	<p>Turn on/off the digital Compass function</p> <ul style="list-style-type: none"> ● Press and hold down the M (5) button to enter the Main Menu. ● Select the Compass menu option with the Up (4)/Down (6) button. ● Briefly press of the M (5) button to turn the digital compass on/off. ● When compass function is turned on, it will reveal in the center of top status bar. 	
<p>Gravity Sensor</p> 	<p>Turn on/off the gravity sensor</p> <ul style="list-style-type: none"> ● Press and hold down the M (5) button to enter the Main Menu. ● Select the Gravity Sensor menu option with the Up (4)/Down (6) button. ● Briefly press of the M (5) button to turn the gravity sensor on/off. ● Two scales are displayed on the both sides of the screen when the gravity sensor is on. ● The left scale shows tilt angle, and the right one shows pitch angle. 	
<p>Reticle</p> 	<p>Setting zeroing profile, reticle type and reticle color</p> <ul style="list-style-type: none"> ● Press and hold down the M (5) button to enter the Main Menu. ● Select the Reticle menu option with the Up (4)/Down (6) button. ● Briefly press of the M (5) button to enter the reticle submenu as below. 	
	<p>Zeroing Profile</p> 	<p>Select zeroing profile</p> <ul style="list-style-type: none"> ● Select Zeroing Profile option with the Up (4)/Down (6) button. ● Briefly press of the M (5) button to enter the zeroing profile submenu. ● Select one of three Profiles (marked with the letters A, B, C) with a short press of the Up (4)/Down (6) button.

	<ul style="list-style-type: none"> ● Briefly press of the M (5) button to confirm your selection. ● The name of the selected profile appears in the status bar at the top of the display. 	
<p style="text-align: center;">Reticle Type</p> 	<p>Select reticle type</p> <ul style="list-style-type: none"> ● Select Reticle Type option with the Up (4)/Down (6) button in the reticle submenu. ● Briefly press of the M (5) button to enter the Reticle Type submenu. ● Select the desired reticle type in the list of seven reticle types with short pressing the Up (4)/Down (6) button. ● The reticle types change as the cursor goes down the reticle type list. ● Confirm your selection with a short press of the M (5) button. 	
<p style="text-align: center;">Reticle Color</p> 	<p>Select reticle color</p> <ul style="list-style-type: none"> ● Select Reticle Color option with the Up (4)/Down (6) button in the reticle submenu. ● Briefly press of the M (5) button to enter the Reticle Color submenu. ● Select the desired reticle color among white, black, red and green 	

		<p>with short pressing the Up (4)/Down (6) button.</p> <ul style="list-style-type: none"> ● The reticle color changes as the cursor goes down the reticle color list. ● Confirm your selection with a short press of the M (5) button.
<p>Zeroing</p> 	<p>To zero your riflescope, you need to set a zeroing profile and zeroing distance first. Rico series support the zeroing distance in the range of 1 to 999 m.</p> <ul style="list-style-type: none"> ● Press and hold down the M (5) button to enter the Main Menu. ● Select the Zeroing menu option with the Up (4)/Down (6) button. ● Briefly press the M (5) button to enter the zeroing submenu (zeroing distance selection). ● Select one Zeroing Distance based on the preset target distance with the Up (4)/Down (6) button. The default values are 100m, 200m, 300m ● Press M (5) button briefly to enter Zeroing Distance submenu as follows. 	
	<p>Zeroing</p> 	<p>If the zeroing distance is the same as the preset distance, you can zero your riflescope directly as follows.</p> <ul style="list-style-type: none"> ● In the Zeroing Distance submenu, select the Zeroing  menu option with the Up (4)/Down (6) button. ● Press M (5) button briefly to enter Zeroing function interface. ● The X and Y coordinates of the reticle are displayed in the upper left corner of the screen. ● Aim and shoot the target. ● Keep the reticle center the aiming point, then press and hold down

	<p>the UP (4) and Down (6) button at the same time until a symbol of freeze ❄ appears on the left of the screen, and the image is frozen.</p> <ul style="list-style-type: none"> ● Adjust the reticle position with the Up (4)/Down (6) button until the reticle matches the point of impact. Briefly press the Menu (5) button to switch the movement direction. ● For a detailed description of the reticle adjusting, please refer to the Section 9 Zeroing. ● Press and hold the Menu (5) button to save the position of reticle and exit to the home screen. 	
<p>Reset Zeroing Distance</p> <p>▼ 000 ▲</p>	<p>If the zeroing distance is not same as the preset object, you can set the distance here.</p> <ul style="list-style-type: none"> ● Select a non-primary distance and enter the submenu for operation with a brief press of the M (5) button. ● Select Reset Zeroing Distance menu item with the Up (4)/Down (6) button. ● Short press the M (5) button to enable resetting the zeroing distance. Two triangle icons will appear above and below the number 0. ● Reset the value of the number from 0 to 9 with the Up (4)/Down (6) button. ● Press the M (5) button briefly to switch among the three numbers. 	

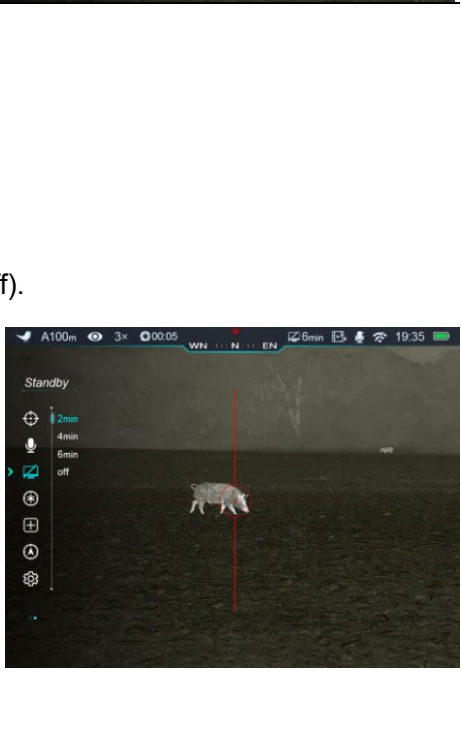
		<ul style="list-style-type: none"> ● After resetting, press and hold the M (5) button to save and exit. ● The new zeroing distance appears in the status bar at the top of the display.
<p style="text-align: center;">Microphone</p> 	<p>Turn the microphone on/off</p> <ul style="list-style-type: none"> ● Press and hold down the M (5) button to enter the Main Menu. ● Select the Microphone menu option with the Up (4)/Down (6) button. ● Briefly press of the M (5) button to turn the microphone function on/off. 	
<p style="text-align: center;">Standby Settings</p> 	<p>Set standby status and time</p> <ul style="list-style-type: none"> ● Press and hold down the M (5) button to enter the Main Menu. ● Select the Standby Settings menu option with the Up (4)/Down (6) button. ● Briefly press the M (5) button to enter the Standby Settings submenu. ● Short press the Up (4)/Down (6) button to select one of four options (2min, 4min, 6min, off). ● Confirm your selection with a short press of M (5) button and reveal in the status bar at the top of the display. ● If the off is selected, it means the standby mode is turned off. <p>Caution:</p> <ul style="list-style-type: none"> - The standby mode will be active when the riflescope is tilted up or down at an angle of more than 70° and left or right at an angle of more than 30°. - The riflescope will not stand by while it is in the firing state. 	



Rangefinder Calibration











When the target position pointed by the laser is not aligned with the center of the rangefinder cursor on the screen, it needs to calibrate the position of laser rangefinder cursor by this function (the rangefinder module is required).





- Press and hold down the **M (5)** button to enter the Main Menu.
- Select the **Rangefinder** menu option with the **Up (4)/Down (6)** button.
- Enter the **Rangefinder Calibration** interface with a short press of the **M (5)** button, meanwhile the laser indicator light will be switched on automatically.
- A small cross cursor appears on the screen, with the prompt information as below shown in the upper left corner:
 - X is the X-axis (horizontal)
 - Y is the Y-axis (vertical)
 - Center means to return the cursor to the center of the screen.
 - Default means to return the cursor to the factory default.
- Select the options with the **Up (4)/Down (6)** button, and confirm your selection with a short press of the **M (5)** button.
- When the **X** or **Y** is selected, the icon will become blue and continuously flashing. Then, move the cursor with a short or long press the **Up (4)/Down (6)** button. Press the **Up (4)** button to move the cursor right or up and the **Down (6)** button to move left or down. Short press to move one pixel every time and long press to move ten pixels once.
- When cursor moved to right position, briefly press the **M (5)** button to save the position, and the icon will stop blinking.
- Switch to another axis and repeat until the cursor is aligned with the target position indicated by the laser.
- When **Center/Default** is selected, briefly press the **M (5)** button to return the cursor to the center/default position.







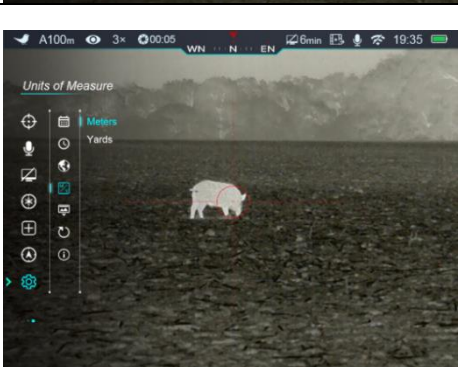

	<ul style="list-style-type: none"> ● Press and hold the M (5) button to save and exit to the home screen.
<p>Pixels Defect Correction</p> 	<p>Defect pixels are pixels that do not change brightness compare with others on the image, they are either brighter or darker than surrounding pixels. Rico series offer the possibility of removing any defective pixels on the sensor using software, as well as to cancel any deletion.</p> <ul style="list-style-type: none"> ● Press and hold down the M (5) button to enter the Main Menu. ● Select the Pixels Defect Correction menu option with the Up (4)/Down (6) button. ● Briefly press the M (5) button to enter the Pixels Defect Correction interface. ● A small cross cursor instead of the reticle will appear on the center of the screen. ● The Picture in Picture (PIP) window will appear on the lower left corner of the screen. ● On the right of PIP window, there are some prompts showing the movement direction of the cursor in X-axis (horizontal), Y-axis (vertical) and number of corrected pixels. ● Select the movement direction with the Up (4) / Down (6) button, and confirm your selection with a short press of the M (5) button. ● When the X or Y is selected, the icon will become blue and continuously flashing. Then, move the cursor to align with the defective pixel with a short or long press the Up (4) / Down (6) button. Press the Up (4) button to move the cursor right or up and the Down (6) button to move left or down. Short press to move one pixel every time and long press to move ten pixels once. ● Delete the defective pixel with a short press of the Power (3) button When the pixel has been successful deleted, the Add message will appear on the PIP window for a short time. 

	<ul style="list-style-type: none"> ● Then, delete the next defective pixel by moving the cursor across the display. ● Press the Power (3) button briefly in the same position as the calibrated defective pixel to cancel the pixel correction, and the Del message will appear on the PIP window for a short time. But it is only limited to not exiting this correction. ● The amount of defect pixels changes each time adding or deleting pixels correction. ● The PIP and the prompt information will move to the upper left of the screen when cursor moves near the lower left corner. ● Press and hold the M (5) button until display shows “Do you want to save these settings?” and “Yes” and “No” options. ● Press the Up (4)/Down (6) button briefly to select ‘Yes’ to save and exit, or select ‘No’ to cancel saving and exit. ● Confirm your selection with a short press of M (5) button. ● If Yes is selected, a 5-second Saving countdown appears on the screen. It will exit to the home screen after the prompt Saving successful appears. 	 
<p style="text-align: center;">Compass Calibration</p> 	<p>Calibrate the digital compass</p> <ul style="list-style-type: none"> ● Press and hold down the M (5) button to enter the Main Menu. ● Select the Compass Calibration menu option with the Up (4)/Down (6) button. ● Briefly press the M (5) button to enter the Compass Calibration submenu. ● An icon like a triaxial coordinate system appears on the screen. ● Follow the icon prompt to rotate the riflescope along three axes at least 360 degrees each 	

	<p>axis in the 15 seconds.</p> <ul style="list-style-type: none"> ● After 15s, the calibration is finished and exit to the home screen. 		
<p style="text-align: center;">Settings</p> 	<p>Select general settings</p> <ul style="list-style-type: none"> ● Press and hold down the M (5) button to enter the Main Menu. ● Select the Settings menu option with the Up (4)/Down (6) button. ● Briefly press the M (5) button to enter the submenu. ● This menu item allows you to configure the following settings. 		
	<p style="text-align: center;">Date</p> 	<p>Date setting</p> <ul style="list-style-type: none"> ● In the Settings submenu, briefly press the M (5) button to activate the Date submenu. Two triangle icons will appear above and below the value. ● Date format is displayed as YY.MM.DD format (2020.01.01). ● Select the correct value for the year, month and date with a short press of the Up (4)/Down (6) button. ● Switch between digits with a short press of the M (5) button. ● Save selected date and exit the submenu with a long press of the M (5) button. 	
	<p style="text-align: center;">Time</p> 	<p>Date setting</p> <ul style="list-style-type: none"> ● In the Settings submenu, briefly press the M (5) button to activate the Time submenu. Two triangle icons will appear above and below the value. 	

	<ul style="list-style-type: none"> ● Time format is displayed as HH:MM in 24-hours format (14:48). ● Select the correct value for the hour and minute with a short press of the Up (4)/Down (6) button. ● Switch between digits with a short press of the M (5) button. ● Save selected date and exit the submenu with a long press of the M (5) button. 	
<p style="text-align: center;">Language</p> 	<p>Language selection</p> <ul style="list-style-type: none"> ● In the Settings submenu, select the Language menu option with the Up (4)/Down (6) button. ● Enter the Language submenu with a short press of the M (5) button. ● Select the desired language with a short press of the Up (4)/Down (6) button. Rico series support English and Russian two languages. ● Confirm your selection with a short press of the M (5) button. ● Submenu exit will take place automatically. 	
<p style="text-align: center;">Units of Measure</p> 	<p>Units of measurement selection</p> <ul style="list-style-type: none"> ● In the Settings submenu, select the Units of Measure menu option with the Up (4)/Down (6) button. ● Enter the Units of Measure submenu with a short press of the M (5) button. 	

	<ul style="list-style-type: none"> ● Select the desired unit between meters and yards with a short press of the Up (4)/Down (6) button. ● Confirm your selection with a short press of the M (5) button. ● Submenu exit will take place automatically.
<p>Status Auto Hiding</p> 	<p>Turn status auto hiding on/off</p> <ul style="list-style-type: none"> ● In the Settings submenu, select the Status Auto Hiding menu option with the Up (4)/Down (6) button. ● Enter the Status Auto Hiding submenu with a short press of the M (5) button. ● Briefly press the Up (4)/Down (6) button to select On or Off. ● Confirm your selection with a short press of the M (5) button. ● Submenu exit will take place automatically. 
<p>Factory Reset</p> 	<p>Reset to Factory Settings</p> <ul style="list-style-type: none"> ● In the Settings submenu, select the Factory Reset menu option with the Up (4)/Down (6) button. ● Enter the Factory Reset submenu with a short press of the M (5) button. ● Briefly press the Up (4)/Down (6) button to select Yes or No. ● Confirm your selection with a short press of the M (5) button. ● The riflescope will reboot if Yes is selected. ● If No is selected, the action will be cancelled and will return to the 

		<p>submenu.</p> <p>The following settings will be returned to the defaults:</p> <ul style="list-style-type: none"> - Image mode: White Hot; - Zeroing: A100 - Ultraclear mode: Off - Magnification: 3.0 x - Calibration mode: Automatic - Digital Compass: Off - Standby: Off - Video output: Off - Wi-Fi: Off - Gravity Sensor: Off - Language: English - Units of Measure: Meter - Status Auto Hiding: Off
	<p>Info</p> 	<p>Show device information</p> <ul style="list-style-type: none"> ● In the Settings submenu, select the Info menu option with the Up (4)/Down (6) button. ● The relevant information of riflescope will be shown by a short press of the M (5) button. ● This item allows the user to view the following information about the riflescope: the product model, GUI version, SYS Info, Boot version, FPGA, PN and SN number of the riflescope, Hardware version. ● Press and hold the M (5) button to return to the submenu. 

17 Laser Indicator and Rangefinder

(Rangefinder Module Required)

Rico series supports to extend the laser rangefinder module (optional) for laser indicator and rangefinder, allowing to measure distance to objects up to 1000m away.

Installation of Laser Rangefinder Module

- Press the button (17) of the rifle mount (22) on the rangefinder module (9) until the clamp (20) is pushed out.
- Move the Clamp (20) to the OPEN position (the position displayed as the fig.).
- Install the mount (22) of the module to the Picatinny rail (23) on the side of the riflescope, and close the clamp (20).
- Adjust the hex-nut (18) on the mount (22) to tighten the module (9) using a hex-nut wrench.
- Then tighten the lock screw (21) on the back of the mount with a hex-nut wrench.
- Connect the Type C plug (24) of the module to the Type C port (10) on

the riflescope to finish the installation.

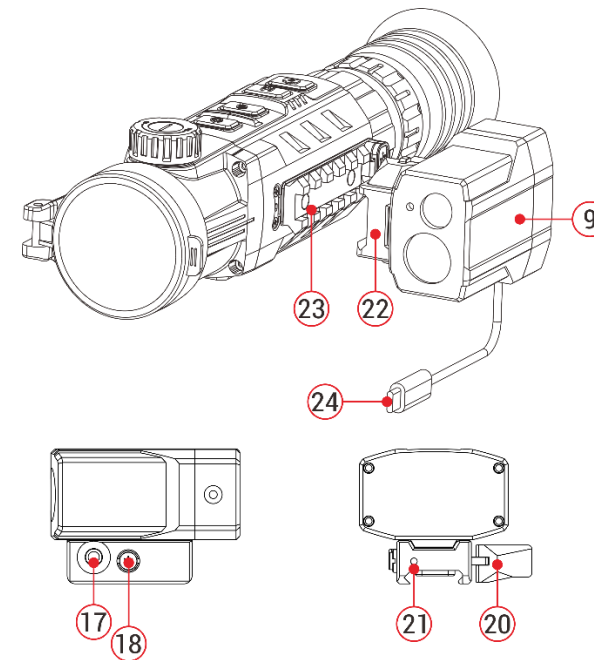

Laser Rangefinder Function

- Press and hold the **Up (4)** and **Down (6)** button simultaneously in the home screen to turn the laser rangefinder function on/off.
- The ranging cursor  appears on the screen. In the top right corner of the display dashes of distance values with measurement unit. And the ranging mode is on the left of the values.
- Rico series have two ranging modes: **SGL** (single ranging) and **CONT**

(Continuous ranging). Briefly press the **Up (4) and Down (6)** button simultaneously to switch between the SGL (the default mode) and CONT mode.

- In the **SGL** mode, press **Power (3)** button to measure the target distance. In SGL mode, the manual calibration function is not available.
- In the **CONT** mode, measurement readings will be refreshed in real time as you point the riflescope at different objects one second without any keystroke operation. The manual calibration function is available in this mode.
- When ranging targets is further than 1000m, the **MAX** will appear in the ranging values.
- To exit the laser rangefinder function, press and hold down the **Up (4) and Down (6)** button simultaneously.



Laser indicator

- In the rangefinder mode, press and hold the **M (5) and Down (6)**

button simultaneously to switch the laser indicator on /off.

Rangefinder Calibration

- It needs to calibrate the rangefinder cursor after the first installation or the target position pointed by the laser is not aligned with the center of the rangefinder cursor on the screen.
- Set a target, then press and hold down the **M (5)** button to enter the Main Menu.
- Select the **Rangefinder** menu option with the **Up (4)/Down (6)** button.
- Enter the **Rangefinder Calibration** interface with a short press of the **M (5)** button, meanwhile the laser indicator light will be switched on automatically.
- A cross cursor appears on the screen instead of the ranging cursor.
- Move the cursor to the position pointed by the laser (refer to the **Main Menu – Rangefinder Calibration**).
- Press and hold the **M (5)** button to save and exit to the home screen.

Caution:

- **Laser function depends on the legal restrictions of different countries and regions.**

- As with any laser device, it is not recommended to directly view the emissions for long periods of time with magnified lenses.
- The laser indicator will not be activated automatically in the laser rangefinder function.
- To set the measurement units (meters or yards), go to **Settings** in the Main Menu.

Peculiarities of Laser Operation

- The accuracy measurement and maximum range depend on the reflection ratio on the target surface, the angle at which the emitting beam falls on the target surface and environmental conditions. Reflectivity is also by surface texture, color, size and shapes of the object. Usually, a glossy and bright surface presents higher reflectivity than a darker surface.
- Accuracy of measurement can also be affected by illumination condition, fog, smog, rain, snow etc. Ranging performance can degrade in bright condition or when ranging towards the sun.
- Measuring range to a small side target is more difficult than a large size target.

18 PIP Function

The PIP (Picture in Picture) function allows you to see both a magnified image in a particular window and the main image.

- Press and hold down the **Zoom (4)** button in the home screen to switch the PIP function on /off.
- When the main image is enlarged with a short press of the **Zoom (4)** button, the PIP image will be enlarged 2× synchronously.
- For example, when the magnification of the main image is 4×, 8×, 12×, 16×, the corresponding magnification of the PIP image is 8×, 16×, 24×, 32×.



19 Status Auto Hiding

This function enables automatic hiding of the GUI information in the interface other than the reticle, so to make the image unobtrusive.

- Press and hold down the **M (5)** button to enter the Main Menu.

- Select the **Settings** menu option with the **Up (4)/Down (6)** button.
- Briefly press the **M (5)** button to enter the submenu.
- Select the **Status Auto Hiding** menu option with the **Up (4)/Down (6)** button.
- Enter the **Status Auto Hiding** submenu with a short press of the **M (5)** button.
- Briefly press the **Up (4)/Down (6)** button to select **On** or **Off**.
- Confirm your selection with a short press of the **M (5)** button.
- When the selecting is **On**, the GUI icons in the interface including the status bar will be automatic hidden after 8 seconds without any operation. Only the image and the reticle will be displayed.
- The GUI information will be displayed again with the press of any button.
- Only after the GUI is displayed, the button and menu can be manipulated.

20 Wi-Fi Function

Rico series ls built-in Wi-Fi module for wireless communication with mobile devices (smartphone or tablet).

- Press and hold down the **M (5)** button to enter the Main Menu.
- Select the **Wi-Fi** menu option with the **Up (4)/Down (6)** button.
- Turn Wi-Fi function on /off with a short press of **M (5)** button.
- The riflescope is recognized by an external device under the name “Rico_XXXXX-XXXXX”, XXXXX-XXXXX is the SN code of the device that consist of numbers and letters.
- Select this Wi-Fi signal, and enter the password (default is 12345678) on the mobile to set up the connection.
- When Wi-Fi is successfully connected, users can manipulate the device via App.
- Launch **InfiRay Outdoor** application on your mobile device (see **Update and APP** section).

Set Wi-Fi Name and

Password

The Wi-Fi name and password of Tube series can be reset in the **InfiRay Outdoor** application.

- After connected with the

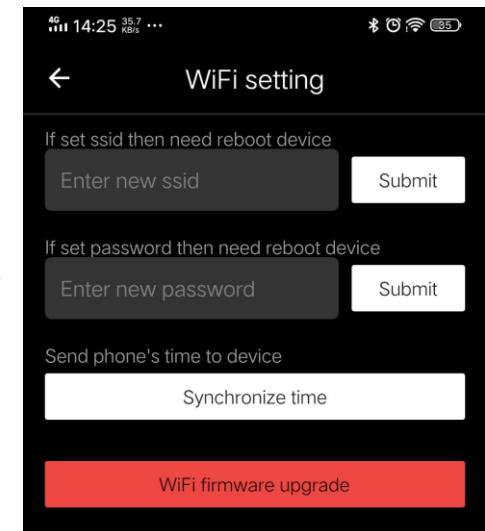

mobile device, find and click the "Setting" icon in the **InfiRay Outdoor** to enter the setting interface.

- In the text box, enter and submit the new name (SSID) and password of the Wi-Fi.
- It needs to reboot the device to take the new name and password effect.

Note: If the device is reset to the factory settings, the name and password of the Wi-Fi will also be restored to the default settings.

21 Updates and InfiRay Outdoor

Tube series thermal imaging riflescopes support **InfiRay Outdoor** technology, which allows you to transmit the image from the thermal imager to the smartphone or tablet via Wi-Fi in real time mode.

You can find detailed instructions on **InfiRay Outdoor** in the separate brochure at the site www.infirayoutdoor.com.

The design of the riflescope provides the software update option. Updating is possible via the **InfiRay Outdoor** application. Also, it is feasible to

download and update software from the official website: www.infirayoutdoor.com.

About InfiRay Outdoor

- You can get **InfiRay Outdoor** application in the official website: www.xinfrared.com; or search **InfiRay Outdoor** in App store to download App; or scan the following QR code to download.



- When installation completed, open InfiRay Outdoor application.
- If your riflescope is already connected with mobile device, please switch on the mobile data in mobile device. After connection, the update detection is performed automatically with a prompt in the application. Click 'Now' to download the updates or click 'Later' to update later.
- **InfiRay Outdoor** will automatically store the last connected device. So, if the riflescope has not connected with your mobile device, but linked to **InfiRay Outdoor** before, the update prompt will appear if there is an update when turning on **InfiRay Outdoor**. You can download the update first via mobile Wi-Fi and then connect the riflescope with mobile device to finish the update.

- After finishing the update, the device will root.

22 Technical Inspection

It is recommended to carry out a technical inspection each time before using the riflescope. Check the following:

- The riflescope appearance (there should be no cracks on the body).
- The condition of the object lens and eyepiece (there should be no cracks, greasy spots, dirt or other deposits).
- The state of rechargeable battery (it should be charged).
- The controls/buttons should be in working order.

23 Maintenance

The maintenance should be carried out at least twice a year and includes the following steps:

Fault	Probable Cause	Solution
Riflescope will not turn on.	Batteries are completely discharged.	Charge the battery.
Riflescope will not work with an	USB cable is damaged.	Replace USB cable.

- Wipe the external surface of metal and plastic parts off dust with a cotton cloth. Silicone grease may be used for cleaning process.
- Clean the electric contacts and battery slots on the riflescope using a non-greasy organic solvent.
- Check the optics of the lens and the eyepiece. If necessary, remove the dirt and sand from the optics (it is perfect to use a non-contact method). Cleaning of the exterior of the optics should be done with cleaners designed especially for this purpose.

24 Trouble shooting

The table lists all the problems that may occur when operating the riflescope. Carry out the recommended checks and troubleshooting steps in the order shown in the table. If there are defects that are not listed in the table or it is impossible to repair the defect yourself, return the riflescope for repair service.

external power supply.	External power source is discharged.	Check the external power source.
The image is fuzzy, not clear, not balanced, with strings	Calibration is required.	Perform image calibration according to the Calibration section of this manual.
The Image is too dark.	Brightness level is too low.	Adjust brightness of screen.
The GUI is clear, but the image is fuzzy.	The lens is not focused.	Adjust the image sharpness by rotating the lens adjuster.
	There is dust or condensate on the interior or exterior optical surfaces of the lens.	Wipe off the outside optical surfaces with a soft cotton cloth. Let the riflescope dry by leaving it in a warm environment for 4 hours.
The aiming reticle shifts after firing rounds.	The riflescope is not mounted securely or the mount is not fixed on the riflescope.	<p>Check that the riflescope has been securely mounted.</p> <p>Make sure you are using the same type and caliber of the bullets as when the riflescope and weapon were initially zeroed.</p> <p>If your riflescope was zeroed in the summer and using in the winter (or the other way round), a slight shift of the zero point is possible.</p>
The image of the object being observed is missing.	Observation through glass.	Remove the glass from the field of vision.
The riflescope will not focus.	Wrong settings.	<p>Adjust the riflescope according to the Powering On and Image Setting section.</p> <p>Check the outer surfaces of the objective lenses and eyepiece and, where necessary, wipe them from dust, condensation, frost, etc.</p> <p>In cold weather, you can use special anti-fogging coatings (e.g., the</p>

		same as for corrective glasses).
The riflescope can't connect with the smartphone and tablet PC.	Wrong Wi-Fi password	Input correct password
	Too many Wi-Fi signals around the device.	Move the device to an area with no or fewer Wi-Fi signals
Wi-Fi signal is missing or interrupted	Smartphone or tablet is out of range of a strong Wi-Fi signal. Or there are obstacles between device and the smartphone or tablet (such as concrete wall).	Replace the device until Wi-Fi signal is stable.
Image quality is too low or the detection range is reduced.	These problems may occur due to the weather condition, such as snow, rain, fog etc.	
When the riflescope is used in the low temperature conditions, the image quality of the surroundings is worse than in positive temperature conditions.	<p>In positive temperature conditions, objects being observed (surroundings and background) heat up differently because of thermal conductivity, thereby generating a high temperature contrast. Accordingly, image quality produced by the thermal imager will be higher.</p> <p>In low temperature conditions, object objects being observed (background) will cool down to roughly the same temperature, as a rule, and thus the temperature contrast is substantially reduced and image quality (zoom) goes down. This is a distinctive feature of the thermal imager.</p>	

25 Legal and Regulatory Information

Wireless transmitter module frequency range: WLAN: 2.400- 2.483 GHz

Wireless transmitter module power: 100 m

 We thus declare that the Rico series complies with the directives 2014/53/EU and 2011/65/EU.

FCC Statement

FCC ID: 2AYGT-RICO

Labeling requirements

This device complies with part 15 of the FCC Rules. Operation is subject to the following two conditions: (1) This device may not cause harmful interference, and (2) this device must accept any interference received, including interference that may cause undesired operation.

Information to the user

Any Changes or modifications not expressly approved by the party responsible for compliance could void the user's authority to operate the equipment.

EMC : Class A

Note: This equipment has been tested and found to comply with the limits for a Class A digital device, pursuant to part 15 of the FCC Rules. These limits are designed to provide reasonable protection against harmful interference when the equipment is operated in a commercial environment. This equipment generates, uses, and can radiate radio frequency energy and, if not installed and used in accordance with the instruction manual, may cause harmful interference to radio communications. Operation of this equipment in a residential area is likely to cause harmful interference in which case the user will be required to correct the interference at his own expense.

To comply with RF exposure requirements, a minimum separation distance of 0.00 cm must be maintained between the user's body and the handset, including the antenna.